

構成内容 / Components				
No.	名称 / Part name	数量 / Pcs	材質 / Material	色・表面処理 / Color・Finish
1	上カバー Top cover	1	アクリル板 t2.0 Acrylic t2.0	透明 Transparent
2	下カバー Bottom cover	1	アクリル板 t2.0 Acrylic t2.0	透明 Transparent
3	パネル Panel	4	アクリル板 t2.0 Acrylic t2.0	透明 Transparent
4	支柱 Extruded pillar	4	アルミ押出材 A6063S-T5 Extruded aluminium A6063S-T5	シルバーアルマイト Silver・Anodized
5	取付け用ローレットビス(M3 x 8) Knurled Thumb Screw(M3 - 8)	4	真ちゅう Brass	ニッケルメッキ Nickel plated
6	取付け用ビス(皿M3 x 8) Screw(M3 - 8)	4	鉄 Steel	三価クロメート Trivalent chromate
7	基板固定用スペーサー Spacer	4	真ちゅう Brass	ニッケルメッキ Nickel plated
8	Raspberry Pi取付け用ビス(ナベM2.5 x 4) Screw for Board(M2.5 - 4)	4	鉄 Steel	三価クロメート Trivalent chromate
9	スペーサー取付け用ビス(皿M2.5 x 5) Screw(M2.5 - 5)	4	鉄 Steel	三価クロメート Trivalent chromate

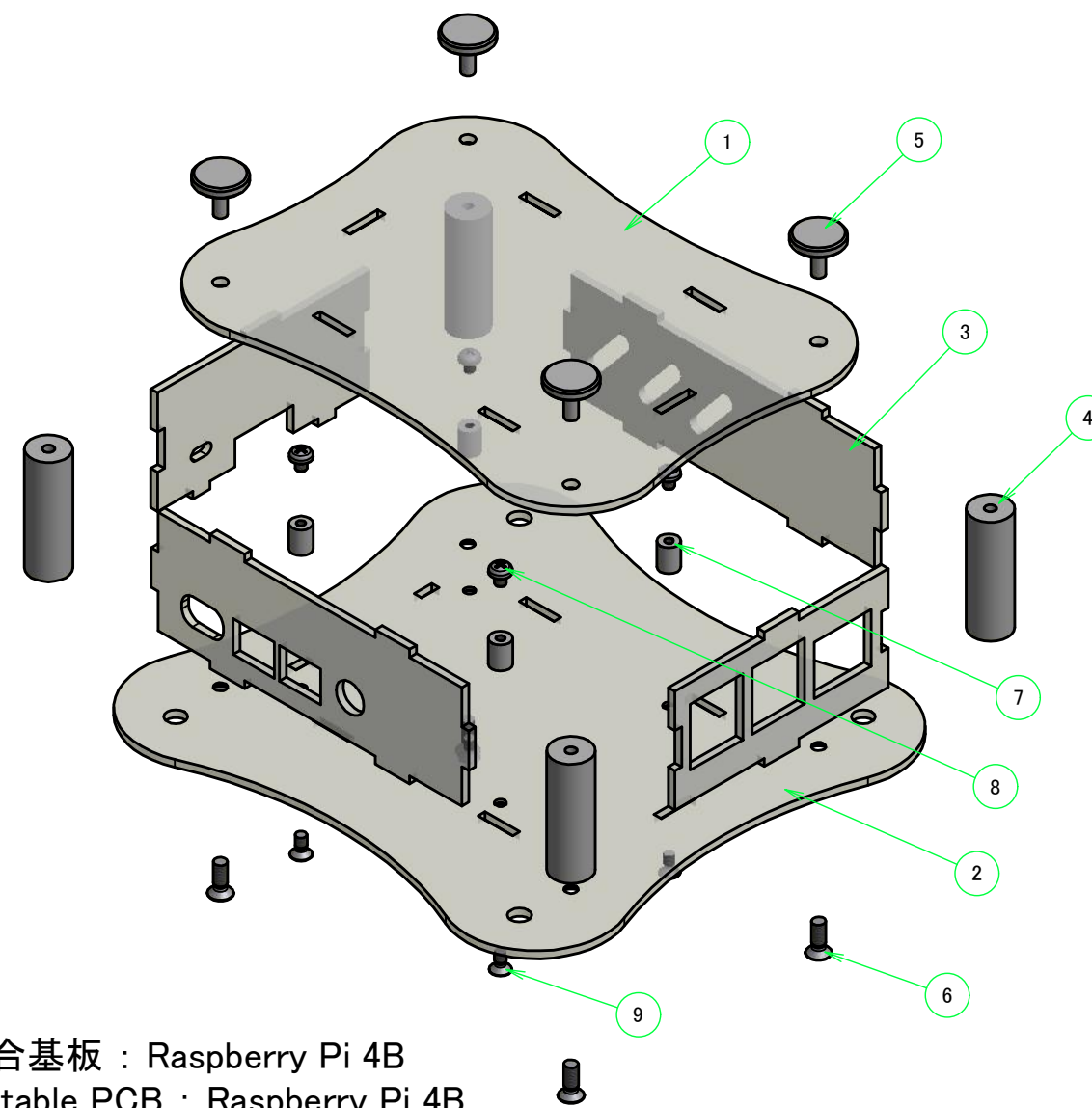

取付け用ローレットビス / Knurled Thumb Screw

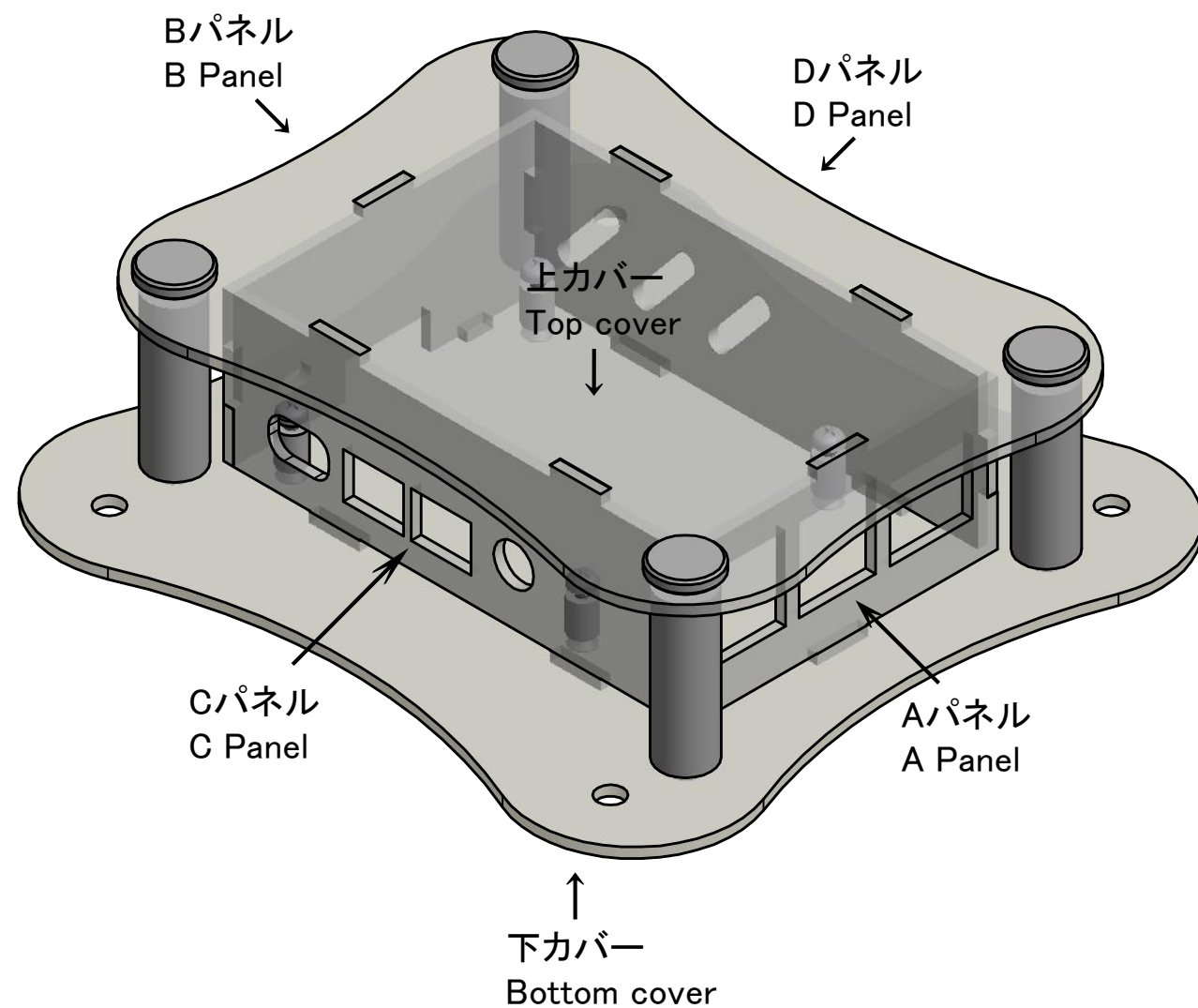

適合基板 : Raspberry Pi 4B
Suitable PCB : Raspberry Pi 4B

株式会社タカチ電機工業 TAKACHI ELECTRONICS ENCLOSURE CO., LTD.			品名/Title Raspberry Pi 4B専用アクリルケース Raspberry Pi 4B ACRYLIC CASE	尺度/Scale 1 / 6
承認/Approved	検図/Checked	製図/Created	型番/Product number RPA-4B-1F 作成日/Date 2023/07/24	
中根	横田	常山		

Bパネル / B Panel

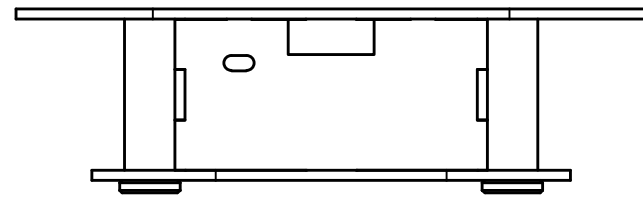

Cパネル / C Panel

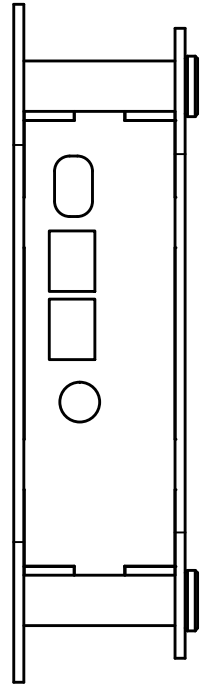

上カバー / Top cover

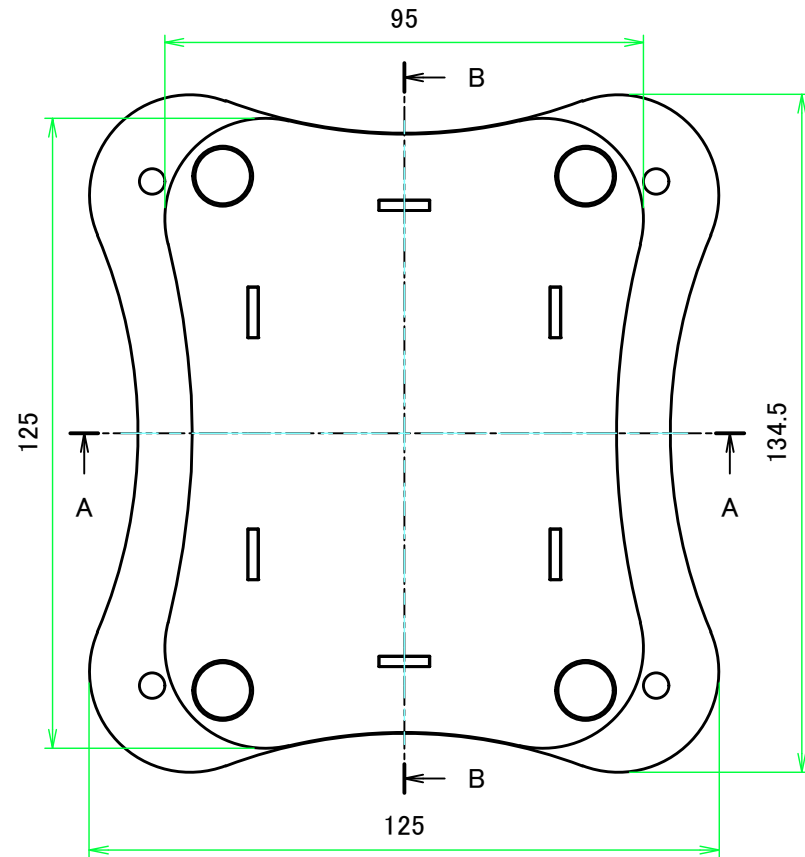

Dパネル / D Panel

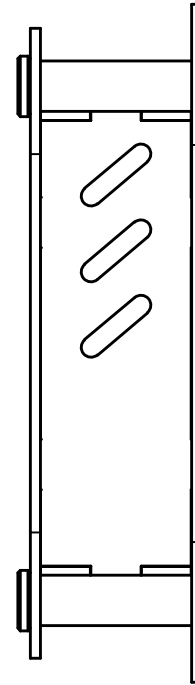

B-B (1:1.5)

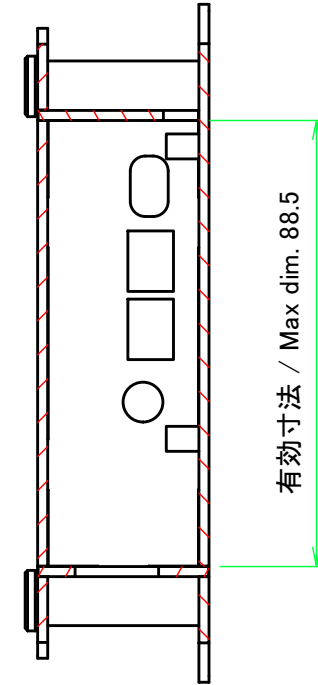

下カバー / Bottom cover

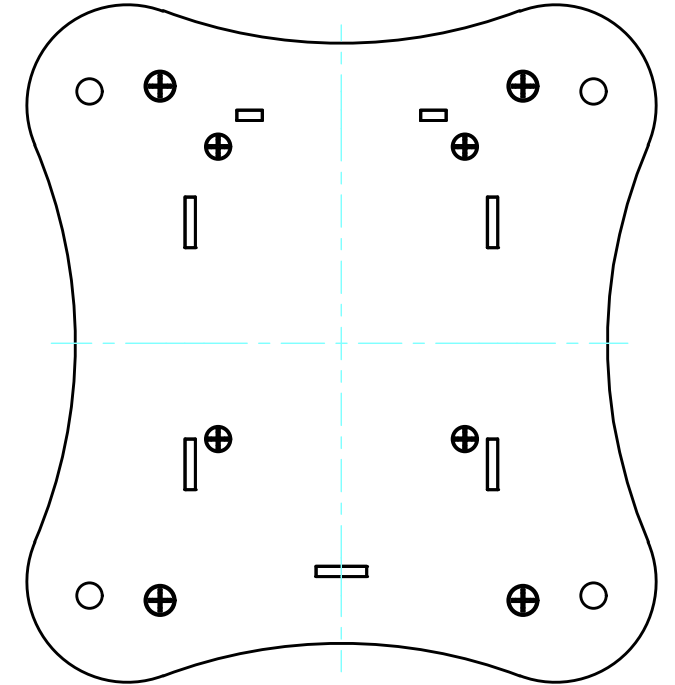

Aパネル / A Panel

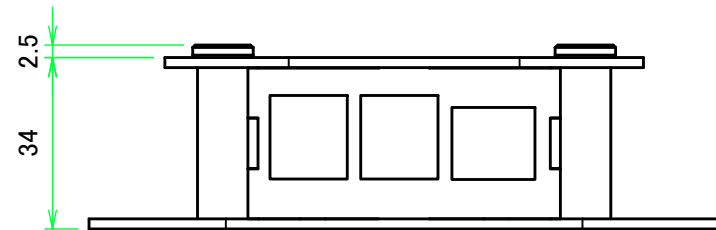

A-A (1:1.5)

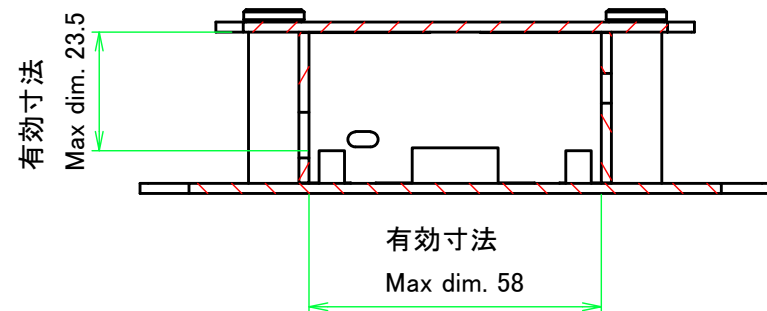

株式会社タカチ電機工業 TAKACHI ELECTRONICS ENCLOSURE CO., LTD.			品名/Title Raspberry Pi 4B専用アクリルケース Raspberry Pi 4B ACRYLIC CASE	尺度/Scale 1:1.5
承認/Approved	検図/Checked	製図/Created	型番/Product number RPA-4B-1F	
中根	横田	常山	作成日/Date 2020/10/30	2 / 6

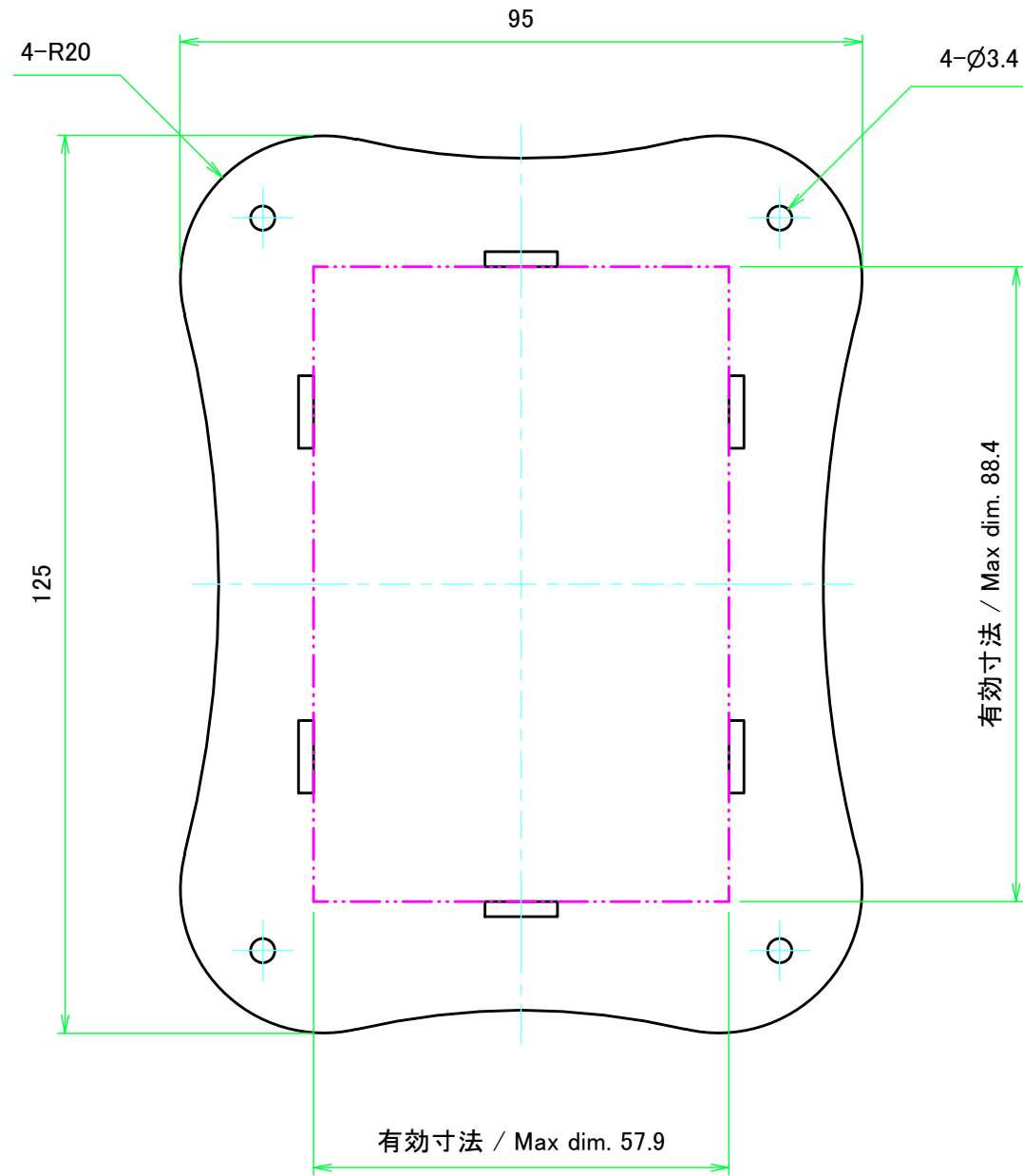

上カバー / Top cover

上カバー表面 / Top cover Frontside

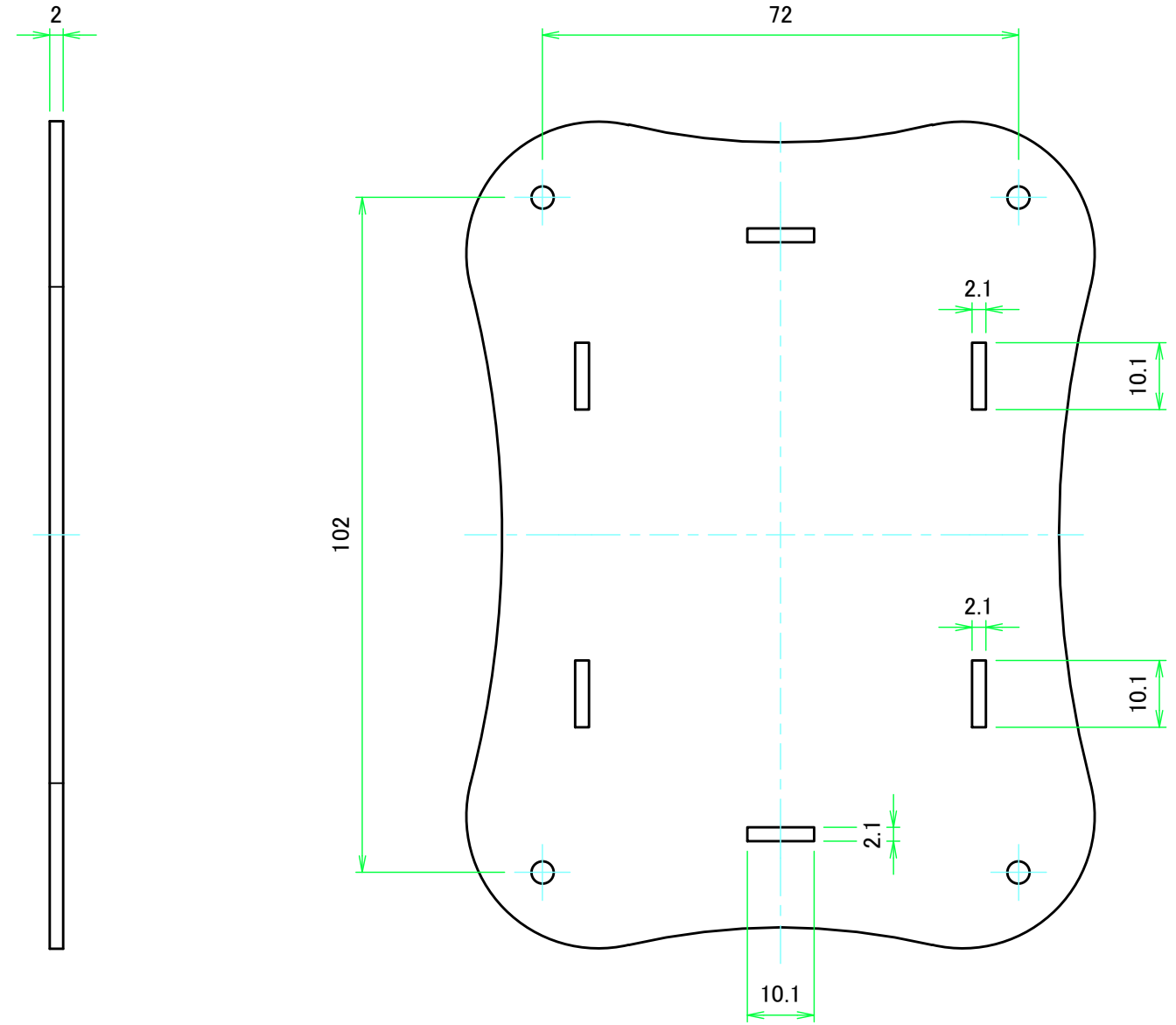

上カバー裏面 / Top cover Backside



 株式会社タカチ電機工業 <small>TAKACHI ELECTRONICS ENCLOSURE CO., LTD.</small>			品名/Title Raspberry Pi 4B専用アクリルケース Raspberry Pi 4B ACRYLIC CASE	 尺度/Scale 1:1
承認/Approved 中根	検図/Checked 横田	製図/Created 常山	型番/Product number RPA-4B-1F	
			作成日/Date 2020/10/30	3 / 6

下カバー / Bottom cover

下カバー表面 / Bottom cover Frontside

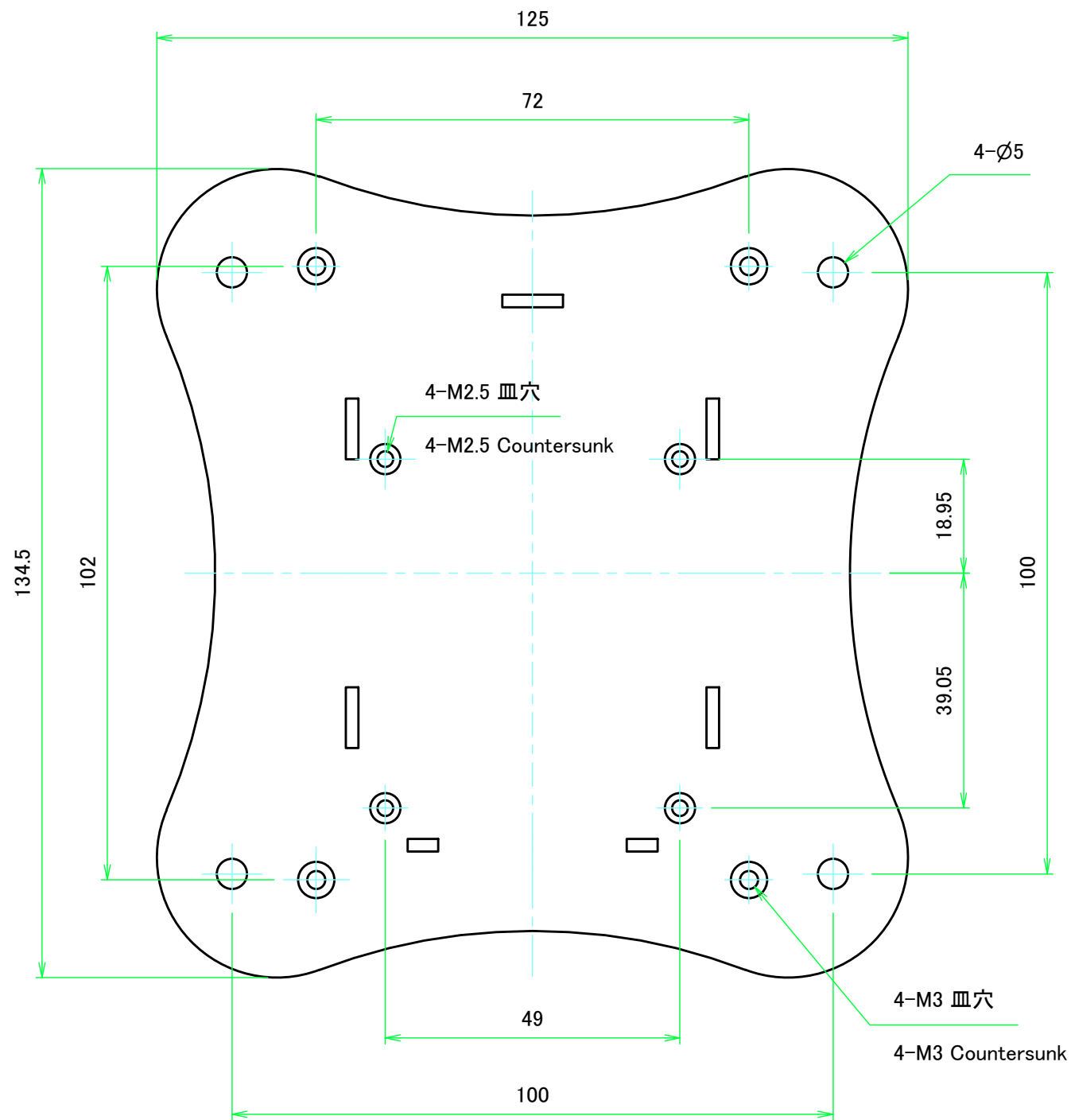

下カバー裏面 / Bottom cover Backside

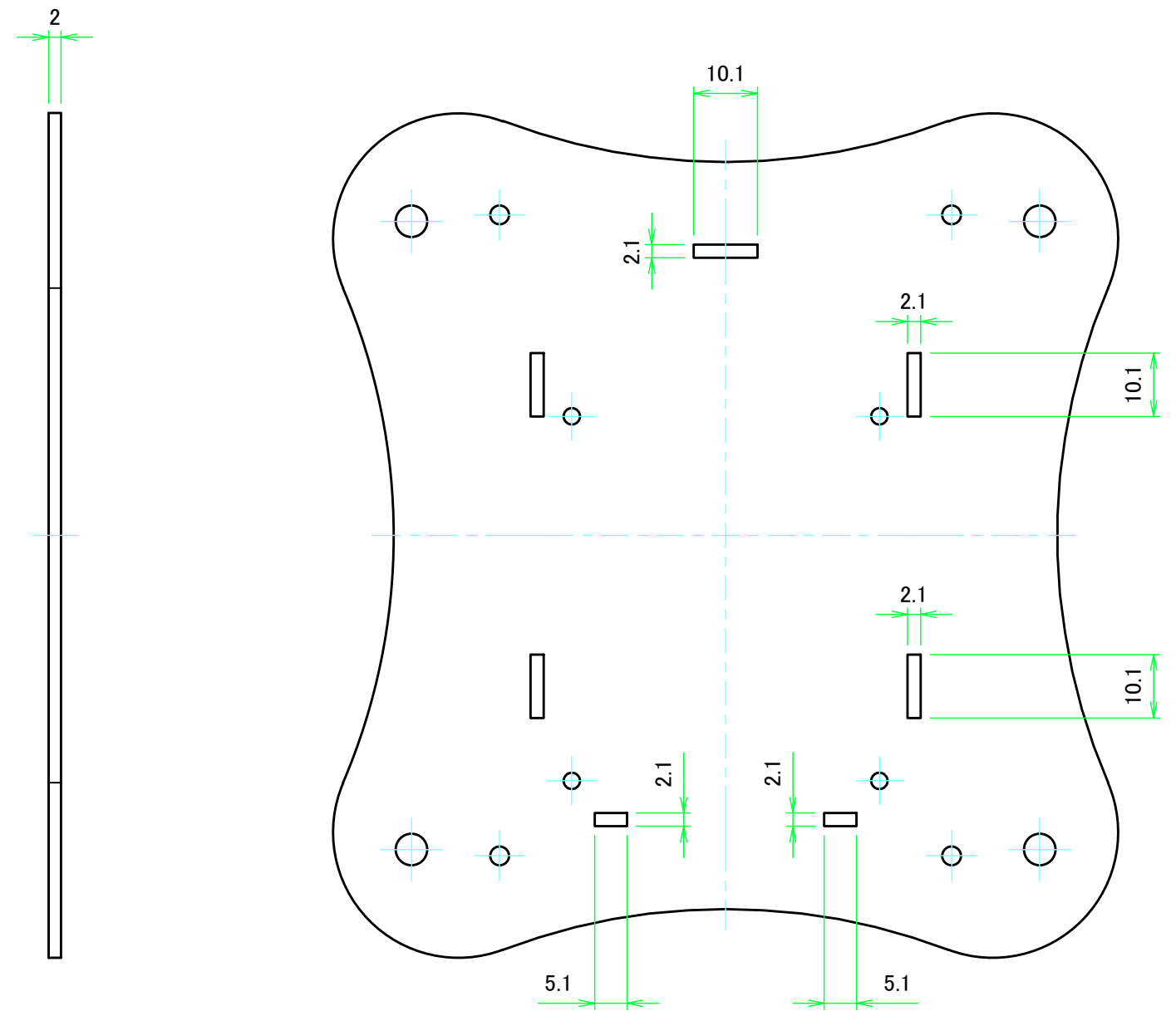

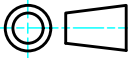
 株式会社タカチ電機工業 TAKACHI ELECTRONICS ENCLOSURE CO., LTD.			品名/Title Raspberry Pi 4B専用アクリルケース Raspberry Pi 4B ACRYLIC CASE	 尺度/Scale 1:1
承認/Approved	検図/Checked	製図/Created	型番/Product number RPA-4B-1F	
中根	横田	常山	作成日/Date 2023/07/24	4 / 6

Aパネル / A Panel

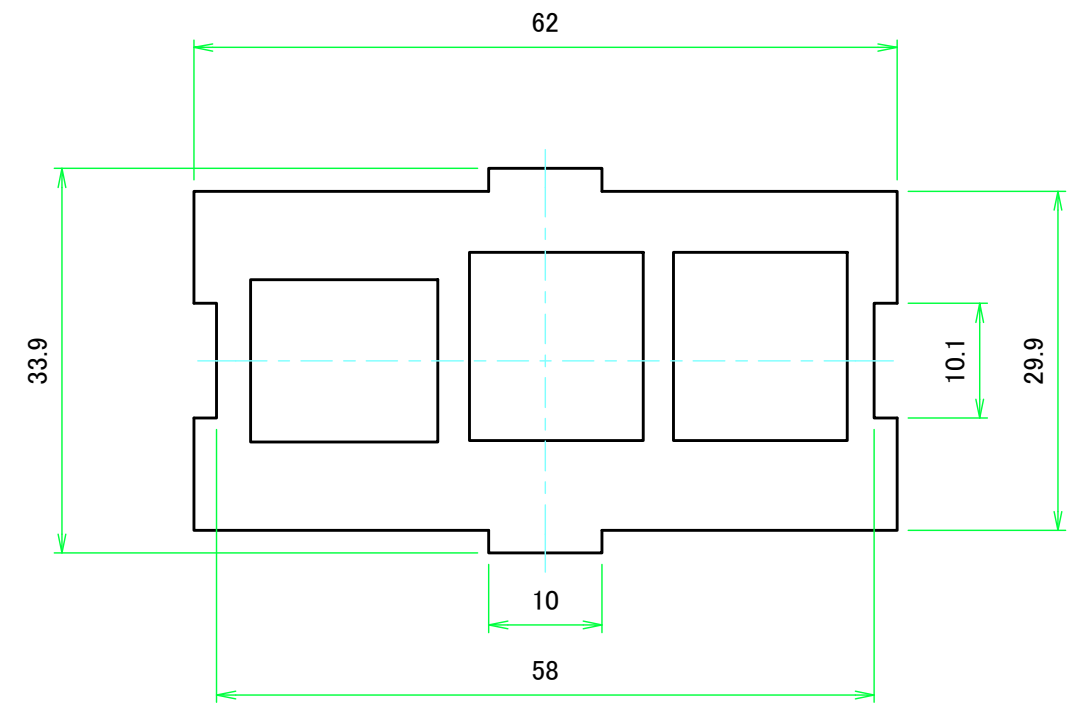
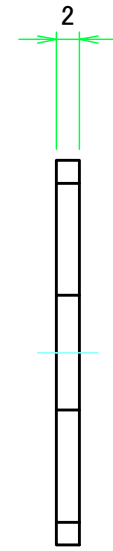
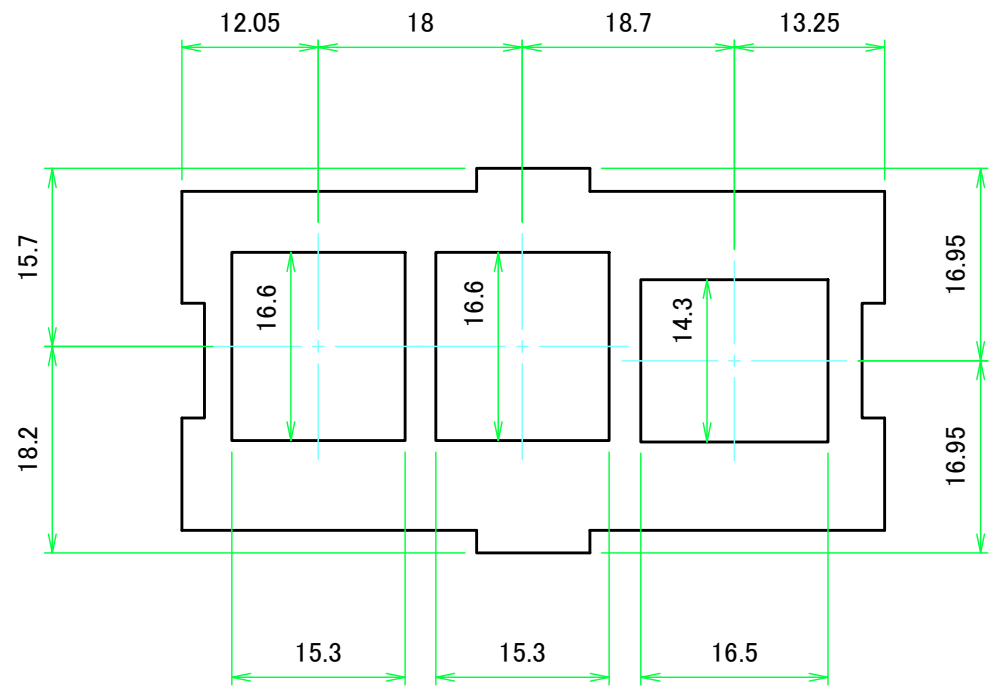

Aパネル表面 / A Panel Frontside

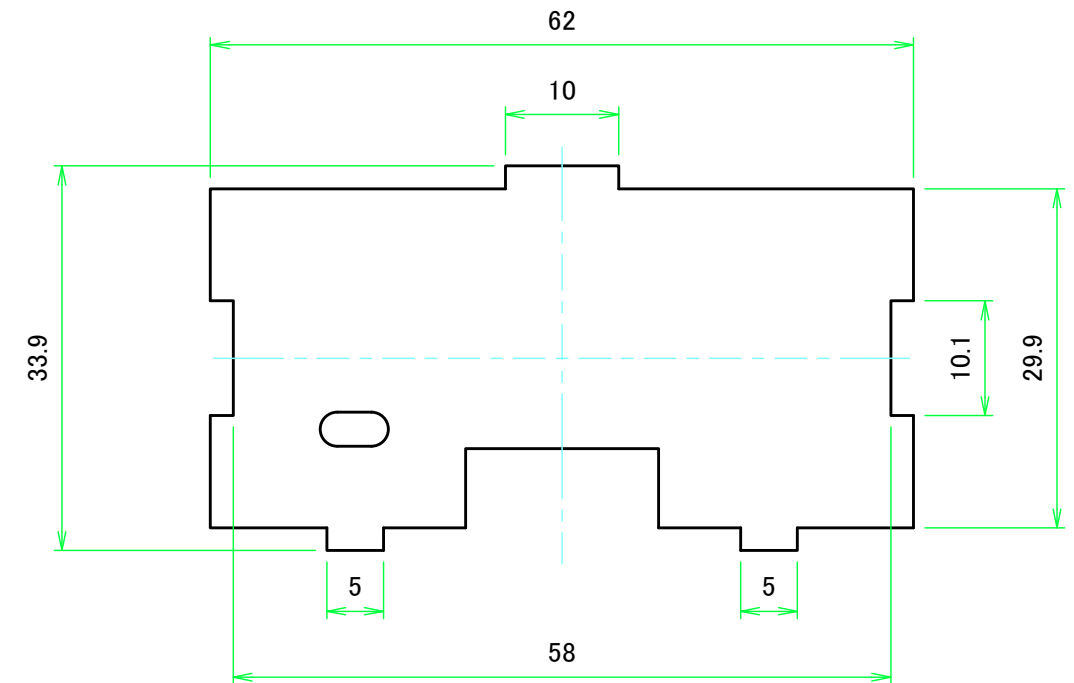
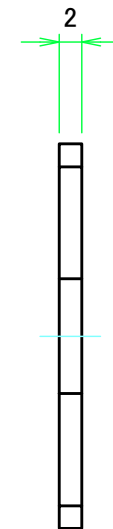
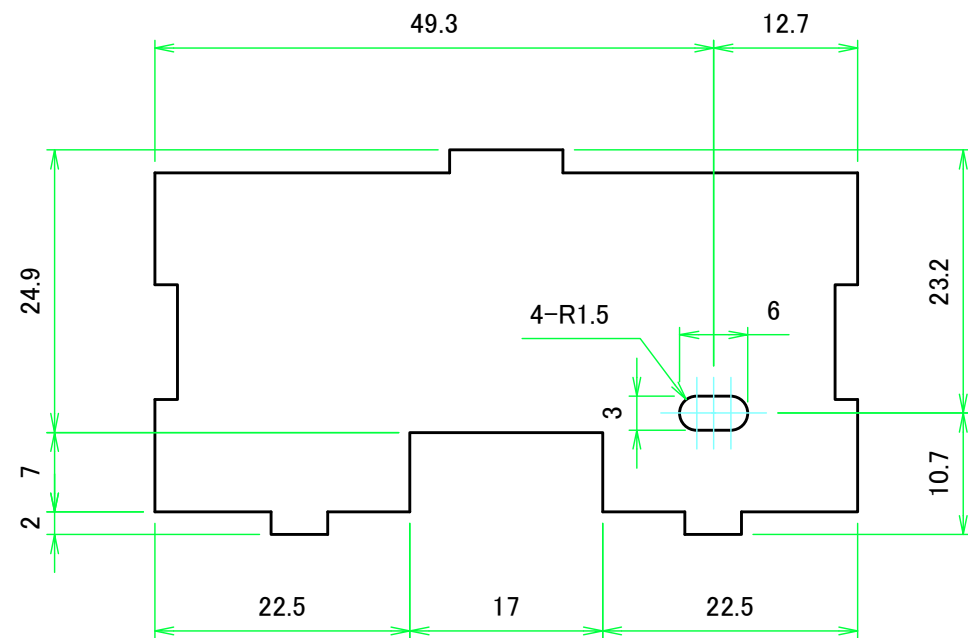

Aパネル裏面 / A Panel Backside

Bパネル / B Panel



Bパネル表面 / B Panel Frontside

Bパネル裏面 / B Panel Backside

 株式会社タカチ電機工業 TAKACHI ELECTRONICS ENCLOSURE CO., LTD.			品名/Title Raspberry Pi 4B専用アクリルケース Raspberry Pi 4B ACRYLIC CASE	 尺度/Scale 1.5:1
承認/Approved	検図/Checked	製図/Created	型番/Product number RPA-4B-1F	
中根	横田	常山	作成日/Date 2020/10/30	5 / 6

Cパネル / C Panel

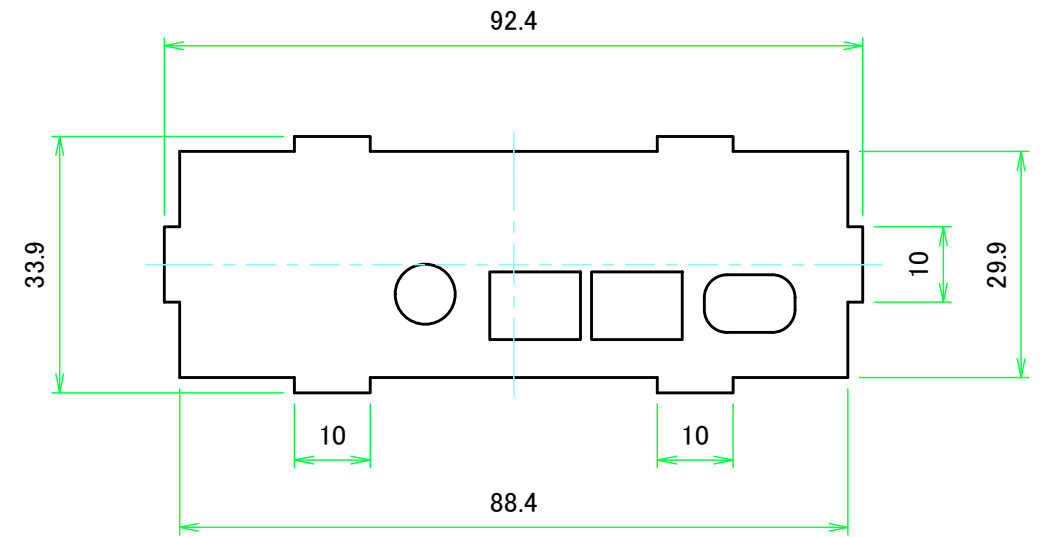
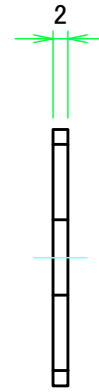
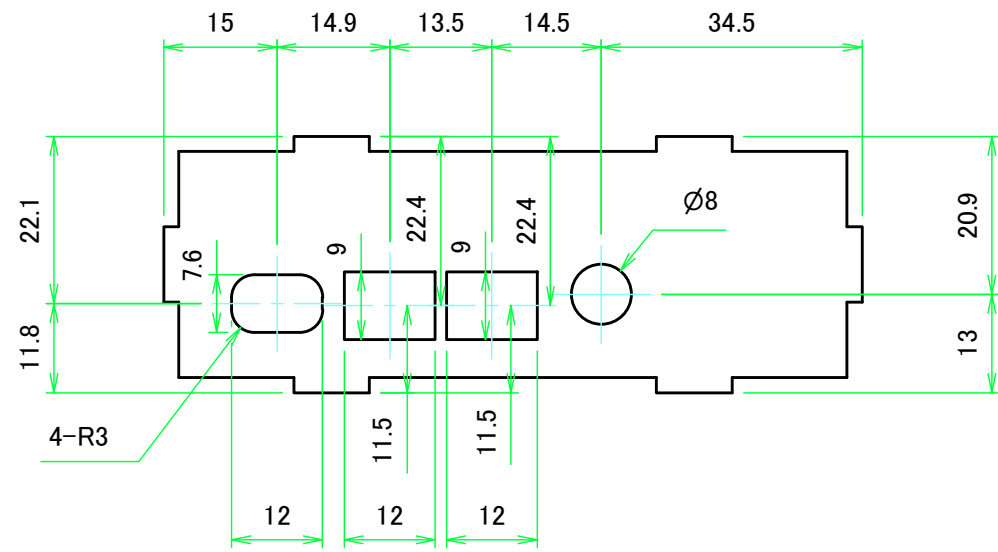

Cパネル表面 / C Panel Frontside

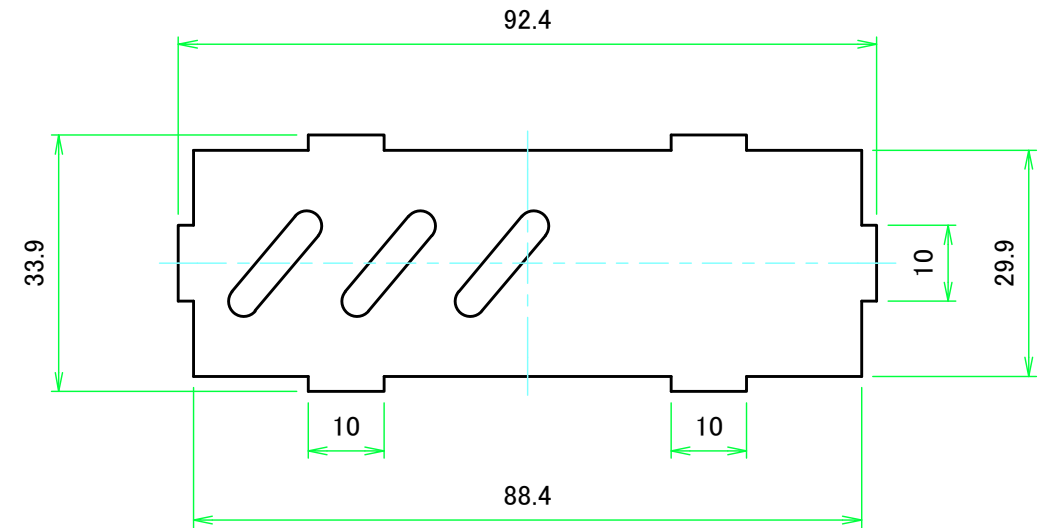
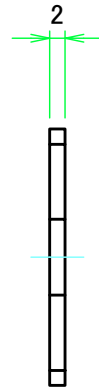
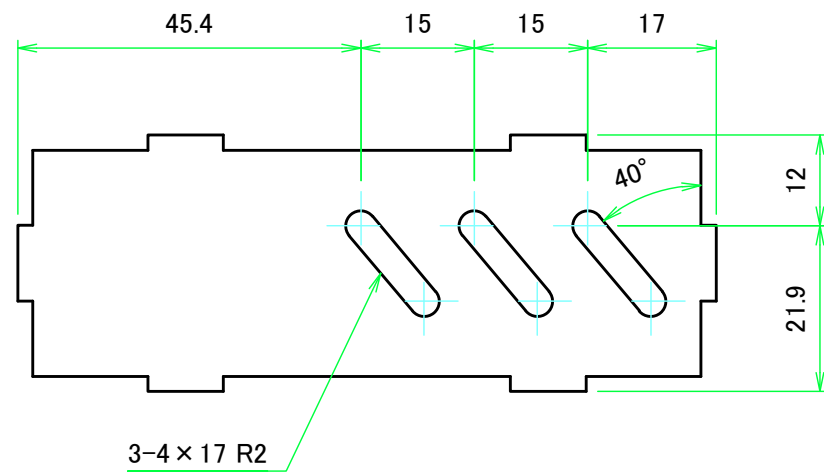

Cパネル裏面 / C Panel Backside

Dパネル / D Panel



Dパネル表面 / D Panel Frontside

Dパネル裏面 / D Panel Backside

 株式会社タカチ電機工業 TAKACHI ELECTRONICS ENCLOSURE CO., LTD.			品名/Title Raspberry Pi 4B専用アクリルケース Raspberry Pi 4B ACRYLIC CASE	 尺度/Scale 1:1
承認/Approved	検図/Checked	製図/Created	型番/Product number RPA-4B-1F	
中根	横田	常山	作成日/Date 2020/10/30	6 / 6